

TYPE		CODE ARTICLE	PRIX EN CHF
TSE-11	Déclenchement horaire et anti-horaire 5 – 55 mNm	01-0002-011	
TSE-21	Déclenchement horaire et blocage anti-horaire 5 – 55 mNm	01-0002-021	
TSE-31	Déclenchement anti-horaire et blocage horaire 5 – 55 mNm	01-0002-031	
TSE-41	Déclenchement horaire et anti-horaire 20 – 80 mNm	01-0002-041	
TSE-51	Déclenchement horaire et blocage anti-horaire 20 – 80 mNm	01-0002-051	
TSE-121	Déclenchement horaire et blocage anti-horaire 20 – 120 mNm	01-0002-121	



TSE-11 à 51



TSE-121



Les Tournevis dynamométriques de type TSE-11 à 51ACR sont livrés **SANS** adaptateur ACR, **SANS** douille de réduction ACR et **SANS** bague d'identification STD (standard), ces fournitures doivent être commandées séparément. Pour les TSE-121, une bague noir est livré **AVEC**.



Tous les tournevis (1) sont livrés dans une boîte (2) avec une clé de réglage (3) du couple et la vis de blocage mèche STD !

FOURNITURES À COMMANDER SÉPARÉMENT	CODE ARTICLE		PRIX EN CHF
1. Adaptateur changement rapide $\varnothing 0.5$ à $\varnothing 3.00$ (TSE-11 à 51 + TSE-121)	10-0008-XXX		
2. Bague d'identification ACR TSE-11 à 51	10-0005-XXX		
3. Bague d'identification ACR TSE121	10-0005-1XX		
4. Douille de réduction ACR TSE-11 à 51	10-0007-XXX		
5. Douille de réduction STD TSE-121	10-0006-XXX		
6. Bague d'identification STD TSE-11 à 51	10-0004-XXX		
7. Bague d'identification 11mm TSE-1X1	10-0004-1XX		
8. Mèches STD $\varnothing 0.5$ à $\varnothing 3.00$	10-0001-XXX 10-0001-XXX R		

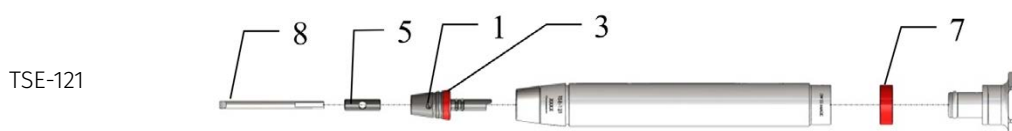
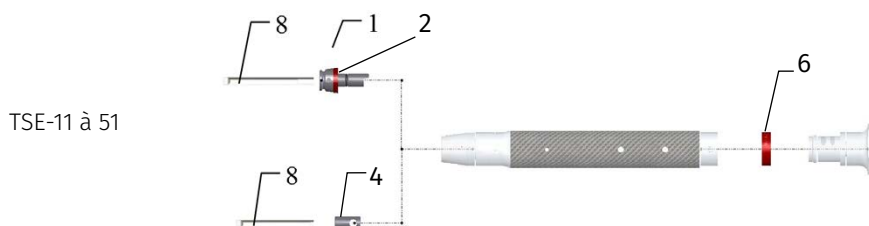

FOURNITURES SAV	CODE ARTICLE	PRIX EN CHF
1. Vis de blocage mèche ACR TSE-11 à 51	10-0016-001	
2. Vis de blocage mèche ACR TSE-1X1	10-0016-006	
3. Joint O-Ring ACR TSE-11 à 51	10-0013-001	
4. Joint O-Ring ACR TSE-1X1	10-0013-004	
5. Vis de blocage mèche STD	10-0016-002	
6. Vis de tourelle TSE-10 à 51	10-0016-004	
7. Vis de tourelle TSE-1X1	10-0016-005	
8. Tourelle	10-0015-XXX	



TSE-11 à 51

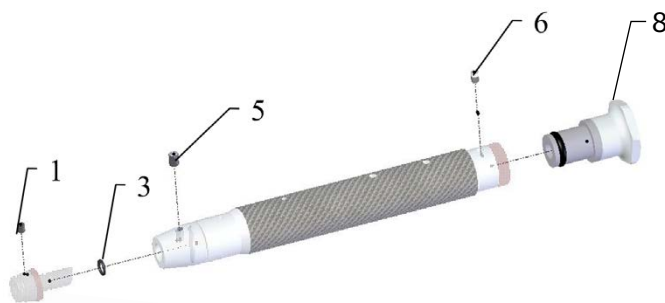

TSE-121

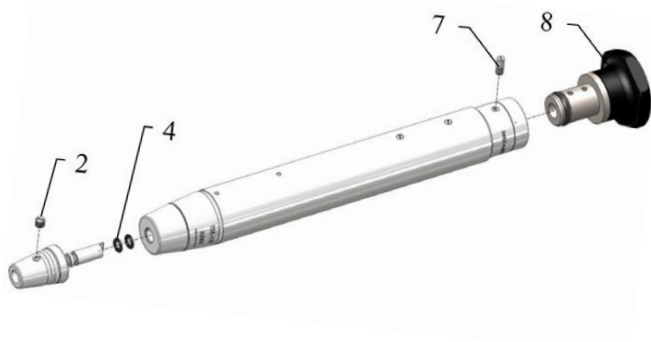

TYPE		CODE ARTICLE	PRIX EN CHF
TSE-11	Déclenchement horaire et anti-horaire 5 – 55 mNm	01-0002-011	401.40
TSE-21	Déclenchement horaire et blocage anti-horaire 5 – 55 mNm	01-0002-021	438.00
TSE-31	Déclenchement anti-horaire et blocage horaire 5 – 55 mNm	01-0002-031	438.00
TSE-41	Déclenchement horaire et anti-horaire 20 – 80 mNm	01-0002-041	462.00
TSE-51	Déclenchement horaire et blocage anti-horaire 20 – 80 mNm	01-0002-051	484.00
TSE-121	Déclenchement horaire et blocage anti-horaire 20 – 120 mNm	01-0002-121	608.00

01-0002-011



01-0002-041/051



01-0002-021



01-0002-121



01-0002-031



## REMISE DE QUANTITÉ

0 à 9 pièces	net	20 à 49 pièces	8%
10 à 19 pièces	5%	50 pièces et +	10%

CODE ARTICLE		DIAMÈTRE	PRIX EN CHF
10-0008-005	Adaptateur à changement rapide	ø 0.50	13.70
10-0008-006	Adaptateur à changement rapide	ø 0.60	13.70
10-0008-007	Adaptateur à changement rapide	ø 0.70	13.70
10-0008-008	Adaptateur à changement rapide	ø 0.80	13.70
10-0008-009	Adaptateur à changement rapide	ø 0.90	13.70
10-0008-010	Adaptateur à changement rapide	ø 1.00	13.70
10-0008-011	Adaptateur à changement rapide	ø 1.10	13.70
10-0008-012	Adaptateur à changement rapide	ø 1.20	13.70
10-0008-013	Adaptateur à changement rapide	ø 1.30	13.70
10-0008-014	Adaptateur à changement rapide	ø 1.40	13.70
10-0008-015	Adaptateur à changement rapide	ø 1.50	13.70
10-0008-016	Adaptateur à changement rapide	ø 1.60	13.70
10-0008-018	Adaptateur à changement rapide	ø 1.80	13.70
10-0008-020	Adaptateur à changement rapide	ø 2.00	13.70
10-0008-025	Adaptateur à changement rapide	ø 2.50	19.90
10-0008-030	Adaptateur à changement rapide	ø 3.00	19.90
10-0008-000	Jeu complet d'adaptateurs ACR	ø 0.5 à 2.00	173.40
10-0008-121	Adaptateur à changement rapide TSE121	ø 3.00	19.90

**REMISE DE QUANTITÉ**

0 à 9 pièces net

10 à 49 pièces 5%

50 à 99 pièces 8%



















100 pièces et + 10%

**POUR TSE-121**



**POUR TSE-11 À 51**





















CODE ARTICLE		POUR Ø DE MÈCHE		COULEURS	PRIX EN CHF
10-0005-005	Bague d'identification ACR	0.50		Orange clair C1	4.00
10-0005-006	Bague d'identification ACR	0.60		Eloxé naturel	4.00
10-0005-007	Bague d'identification ACR	0.70		Or D1	4.00
10-0005-008	Bague d'identification ACR	0.80		Jaune E3	4.00
10-0005-009	Bague d'identification ACR	0.90		Vert clair K3	4.00
10-0005-010	Bague d'identification ACR	1.00		Noir J3	4.00
10-0005-011	Bague d'identification ACR	1.10		Gris foncé J2	4.00
10-0005-012	Bague d'identification ACR	1.20		Rouge B3	4.00
10-0005-013	Bague d'identification ACR	1.30		Brun clair I1	4.00
10-0005-014	Bague d'identification ACR	1.40		Gris clair J1	4.00
10-0005-015	Bague d'identification ACR	1.50		Bleu F3	4.00
10-0005-016	Bague d'identification ACR	1.60		Violet K1	4.00
10-0005-018	Bague d'identification ACR	1.80		Orange foncé C3	4.00
10-0005-020	Bague d'identification ACR	2.00		Vert foncé H3	4.00
10-0005-030	Bague d'identification ACR			Rose B1	4.00
10-0005-031	Bague d'identification ACR			Bleu foncé G3	4.00
10-0005-032	Bague d'identification ACR			Brun foncé I3	4.00
10-0005-033	Bague d'identification ACR			Bleu clair F1	4.00
10-0005-000	Jeu complet de bagues ACR	0.50 à 2.00			56.00

#### REMISE DE QUANTITÉ

0 à 9 pièces	net	50 à 99 pièces	8%
10 à 49 pièces	5%	100 pièces et +	10%









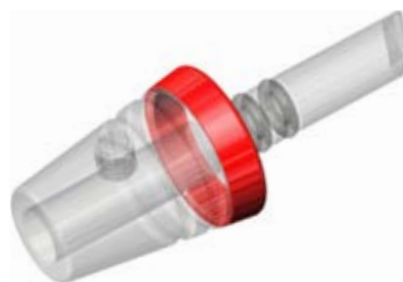











CODE ARTICLE		POUR Ø DE MÈCHE		COULEURS	PRIX EN CHF
10-0005-105	Bague d'identification ACR	0.50		Orange clair C1	9.50
10-0005-106	Bague d'identification ACR	0.60		Eloxé naturel	9.50
10-0005-107	Bague d'identification ACR	0.70		Or D1	9.50
10-0005-108	Bague d'identification ACR	0.80		Jaune E3	9.50
10-0005-109	Bague d'identification ACR	0.90		Vert clair K3	9.50
10-0005-110	Bague d'identification ACR	1.00		Noir J3	9.50
10-0005-111	Bague d'identification ACR	1.10		Gris foncé J2	9.50
10-0005-112	Bague d'identification ACR	1.20		Rouge B3	9.50
10-0005-113	Bague d'identification ACR	1.30		Brun clair I1	9.50
10-0005-114	Bague d'identification ACR	1.40		Gris clair J1	9.50
10-0005-115	Bague d'identification ACR	1.50		Bleu F3	9.50
10-0005-116	Bague d'identification ACR	1.60		Violet K1	9.50
10-0005-118	Bague d'identification ACR	1.80		Orange foncé C3	9.50
10-0005-120	Bague d'identification ACR	2.00		Vert foncé H3	9.50
10-0005-130	Bague d'identification ACR			Rose B1	9.50
10-0005-131	Bague d'identification ACR			Bleu foncé G3	9.50
10-0005-132	Bague d'identification ACR			Brun foncé I3	9.50
10-0005-133	Bague d'identification ACR			Bleu clair F1	9.50
10-0005-200	Jeu complet bagues ACR	0.50 à 2.00			132.00

#### REMISE DE QUANTITÉ

0 à 9 pièces	net	50 à 99 pièces	8%
10 à 49 pièces	5%	100 pièces et +	10%





















CODE ARTICLE		POUR Ø DE MÈCHE		COULEURS	PRIX EN CHF
10-0004-005	Bague d'identification 9mm STD	0.50		Orange clair C1	4.60
10-0004-006	Bague d'identification 9mm STD	0.60		Eloxé naturel	4.60
10-0004-007	Bague d'identification 9mm STD	0.70		Or D1	4.60
10-0004-008	Bague d'identification 9mm STD	0.80		Jaune E3	4.60
10-0004-009	Bague d'identification 9mm STD	0.90		Vert clair K3	4.60
10-0004-010	Bague d'identification 9mm STD	1.00		Noir J3	4.60
10-0004-011	Bague d'identification 9mm STD	1.10		Gris foncé J2	4.60
10-0004-012	Bague d'identification 9mm STD	1.20		Rouge B3	4.60
10-0004-013	Bague d'identification 9mm STD	1.30		Brun clair I1	4.60
10-0004-014	Bague d'identification 9mm STD	1.40		Gris clair J1	4.60
10-0004-015	Bague d'identification 9mm STD	1.50		Bleu F3	4.60
10-0004-016	Bague d'identification 9mm STD	1.60		Violet K1	4.60
10-0004-018	Bague d'identification 9mm STD	1.80		Orange foncé C3	4.60
10-0004-020	Bague d'identification 9mm STD	2.00		Vert foncé H3	4.60
10-0004-022	Bague d'identification 9mm STD	2.20		Rose B1	4.60
10-0004-025	Bague d'identification 9mm STD	2.50		Bleu foncé G3	4.60
10-0004-030	Bague d'identification 9mm STD	3.00		Brun foncé I3	4.60
10-0004-040	Bague d'identification 9mm STD			Bleu clair F1	4.60
10-0004-000	Jeu complet bagues 9mm STD	0.50 à 2.00			67.50

**REMISE DE QUANTITÉ**

0 à 9 pièces	net	50 à 99 pièces	8%
10 à 49 pièces	5%	100 pièces et +	10%





CODE ARTICLE		POUR Ø DE MÈCHE		COULEURS	PRIX EN CHF
10-0004-105	Bague d'identification 11mm STD	0.50		Orange clair C1	4.60
10-0004-106	Bague d'identification 11mm STD	0.60		Eloxé naturel	4.60
10-0004-107	Bague d'identification 11mm STD	0.70		Or D1	4.60
10-0004-108	Bague d'identification 11mm STD	0.80		Jaune E3	4.60
10-0004-109	Bague d'identification 11mm STD	0.90		Vert clair K3	4.60
10-0004-110	Bague d'identification 11mm STD	1.00		Noir J3	4.60
10-0004-111	Bague d'identification 11mm STD	1.10		Gris foncé J2	4.60
10-0004-112	Bague d'identification 11mm STD	1.20		Rouge B3	4.60
10-0004-113	Bague d'identification 11mm STD	1.30		Brun clair I1	4.60
10-0004-114	Bague d'identification 11mm STD	1.40		Gris clair J1	4.60
10-0004-115	Bague d'identification 11mm STD	1.50		Bleu F3	4.60
10-0004-116	Bague d'identification 11mm STD	1.60		Violet K1	4.60
10-0004-118	Bague d'identification 11mm STD	1.80		Orange foncé C3	4.60
10-0004-120	Bague d'identification 11mm STD	2.00		Vert foncé H3	4.60
10-0004-122	Bague d'identification 11mm STD	2.20		Rose B1	4.60
10-0004-125	Bague d'identification 11mm STD	2.50		Bleu foncé G3	4.60
10-0004-130	Bague d'identification 11mm STD	3.00		Brun foncé I3	4.60
10-0004-140	Bague d'identification 11mm STD			Bleu clair F1	4.60
10-0004-100	Jeu complet bagues 11mm STD	0.50 à 3.00			67.50

## REMISE DE QUANTITÉ

0 à 9 pièces	net	50 à 99 pièces	8%
10 à 49 pièces	5%	100 pièces et +	10%



CODE ARTICLE		DIAMÈTRE	PRIX EN CHF
10-0007-005	Douille de réduction ACR	ø 0.50	16.60
10-0007-006	Douille de réduction ACR	ø 0.60	16.60
10-0007-007	Douille de réduction ACR	ø 0.70	16.60
10-0007-008	Douille de réduction ACR	ø 0.80	16.60
10-0007-009	Douille de réduction ACR	ø 0.90	8.40
10-0007-010	Douille de réduction ACR	ø 1.00	8.40
10-0007-011	Douille de réduction ACR	ø 1.10	8.40
10-0007-012	Douille de réduction ACR	ø 1.20	8.40
10-0007-013	Douille de réduction ACR	ø 1.30	8.40
10-0007-014	Douille de réduction ACR	ø 1.40	8.40
10-0007-015	Douille de réduction ACR	ø 1.50	8.40
10-0007-016	Douille de réduction ACR	ø 1.60	8.40
10-0007-018	Douille de réduction ACR	ø 1.80	8.40
10-0007-020	Douille de réduction ACR	ø 2.00	8.40
10-0007-025	Douille de réduction ACR	ø 2.50	8.40
10-0007-000	Jeu complet douilles ACR	ø 0.5 à 2.00	150.00

**REMISE DE QUANTITÉ**

0 à 9 pièces	net	50 à 99 pièces	8%
10 à 49 pièces	5%	100 pièces et +	10%



CODE ARTICLE		DIAMÈTRE	PRIX EN CHF
10-0006-005	Douille de réduction STD	ø 0.50	16.60
10-0006-006	Douille de réduction STD	ø 0.60	16.60
10-0006-007	Douille de réduction STD	ø 0.70	16.60
10-0006-008	Douille de réduction STD	ø 0.80	16.60
10-0006-009	Douille de réduction STD	ø 0.90	8.40
10-0006-010	Douille de réduction STD	ø 1.00	8.40
10-0006-011	Douille de réduction STD	ø 1.10	8.40
10-0006-012	Douille de réduction STD	ø 1.20	8.40
10-0006-013	Douille de réduction STD	ø 1.30	8.40
10-0006-014	Douille de réduction STD	ø 1.40	8.40
10-0006-015	Douille de réduction STD	ø 1.50	8.40
10-0006-016	Douille de réduction STD	ø 1.60	8.40
10-0006-018	Douille de réduction STD	ø 1.80	8.40
10-0006-020	Douille de réduction STD	ø 2.00	8.40
10-0006-025	Douille de réduction STD	ø 2.50	8.40
10-0006-000	Jeu complet douille STD ø0.5 à ø2.0	ø 0.5 à 2.00	150.00

## REMISE DE QUANTITÉ

0 à 9 pièces	net	50 à 99 pièces	8%
10 à 49 pièces	5%	100 pièces et +	10%









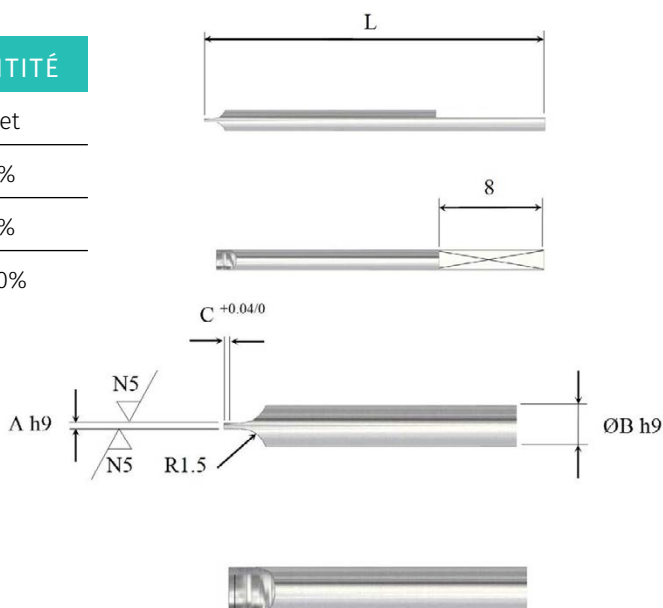

CODE ARTICLE*	* Toutes nos mèches standards existent avec une retenue de 1mm à l'extrémité du plat de serrage		Ø DE MÈCHE	PRIX EN CHF
10-0001-005 / 10-0001-005R		Mèche STD pour vis à fente	$\phi$ 0.50	9.10
10-0001-006 / 10-0001-006R		Mèche STD pour vis à fente	$\phi$ 0.60	9.10
10-0001-007 / 10-0001-007R		Mèche STD pour vis à fente	$\phi$ 0.70	9.10
10-0001-008 / 10-0001-008R		Mèche STD pour vis à fente	$\phi$ 0.80	9.10
10-0001-009 / 10-0001-009R		Mèche STD pour vis à fente	$\phi$ 0.90	9.10
10-0001-010 / 10-0001-010R		Mèche STD pour vis à fente	$\phi$ 1.00	9.10
10-0001-011 / 10-0001-011R		Mèche STD pour vis à fente	$\phi$ 1.10	9.10
10-0001-012 / 10-0001-012R		Mèche STD pour vis à fente	$\phi$ 1.20	9.10
10-0001-013 / 10-0001-013R		Mèche STD pour vis à fente	$\phi$ 1.30	9.10
10-0001-014 / 10-0001-014R		Mèche STD pour vis à fente	$\phi$ 1.40	9.10
10-0001-015 / 10-0001-015R		Mèche STD pour vis à fente	$\phi$ 1.50	9.10
10-0001-016 / 10-0001-016R		Mèche STD pour vis à fente	$\phi$ 1.60	9.10
10-0001-018 / 10-0001-018R		Mèche STD pour vis à fente	$\phi$ 1.80	9.10
10-0001-020 / 10-0001-020R		Mèche STD pour vis à fente	$\phi$ 2.00	9.10
10-0001-025 / 10-0001-025R		Mèche STD pour vis à fente	$\phi$ 2.50	9.10
10-0001-030 / 10-0001-030R		Mèche STD pour vis à fente	$\phi$ 3.00	9.10
10-0001-000 / 10-0001-000R		Jeu complet de mèches	$\phi$ 0.5 à 2.00	12740







**REMISE DE QUANTITÉ**

0 à 9 pièces	net
10 pièces	3%
20 pièces	5%
50 pièces	10%

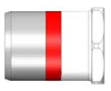
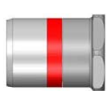

Ah9	ØB H9	C +0.04/0	L
0.1	0.5	0.15	22
0.12	0.6	0.15	22
0.14	0.7	0.18	22
0.14	0.8	0.18	22
0.14	0.9	0.18	22
0.14	1.0	0.18	22
0.14	1.1	0.18	22
0.14	1.2	0.18	22
0.16	1.3	0.2	29
0.16	1.4	0.2	29
0.16	1.5	0.2	29
0.16	1.6	0.2	29
0.2	1.8	0.25	29
0.2	2.0	0.25	29
0.25	2.5	0.28	29
0.25	3.0	0.28	29

CODE ARTICLE		QTÉS. MIN.		PRIX (EN CHF) UNITAIRE
10-0016-001	Vis de blocage mèche ACR M1.6x2.1	20 pièces		1.10
10-0016-002	Vis de blocage mèche STD M2x3	20 pièces		0.70
10-0016-003	Vis de blocage mèche STD M2x5	20 pièces		0.70
10-0016-004	Vis de tourelle TSE-10 à 51	20 pièces		1.10
10-0016-005	Vis de tourelle TSE-1X1	20 pièces		1.10
10-0016-006	Vis de blocage mèche STD M2x2	20 pièces		1.10
10-0013-001	Joint O-Ring ACR	50 pièces		0.60
10-0013-005	Joint O-Ring pour tourelle TSE	50 pièces		0.60

POUR		CODE ARTICLE		PRIX EN CHF
TSE-20/21/50	Tourelle tournevis éloxée «naturelle»	10-0015-001		26.40
TSE-30/31	Tourelle tournevis éloxée «grise»	10-0015-002		26.40
TSE-10/11/40/41	Tourelle tournevis éloxée «noire»	10-0015-003		26.40
TSE-1X1	Tourelle tournevis éloxée «noire»	10-0015-020		26.40
TR-10/11	Tourelle tournevis éloxée «noire»	10-0017-001		26.40
TR-20/21	Tourelle tournevis éloxée «naturelle»	10-0017-002		26.40
TR-30/31	Tourelle tournevis éloxée «grise»	10-0017-003		26.40
CM-02/05/50/100	Tourelle couplemètre éloxée «naturelle»	10-0014-001		18.70
	Bague téflon	10-0017-004		6.10 ou 5.60 dès 100 pièces